



轉出生態道

SPIN FOR SURVIVAL

小學生摩天輪車廂設計比賽

PRIMARY SCHOOL OBSERVATION WHEEL CABIN DESIGN COMPETITION

比賽主題 Theme

用行動保護海洋

Actions to protect the oceans

比賽目的 Objective

透過小學生的集體創意，推動大眾以實際行動保護海洋

Encourage general public to protect oceans with actions through collective creativity from primary school students.

獎品 Prizes

1. 每名得獎學生可獲贈4張摩天輪門票及正宗比利時窩夫及飲品。

Each student of the winning teams will receive 4 HKOW tickets and a delicious authentic Belgian Waffle with refreshing drink.

2. 得獎作品及學校校徽將於2017年4月裱印在摩天輪的車廂上作展覽。

Winning designs and the school badge will be printed on the cabin for exhibition during the whole month of April, 2017.

3. 得獎學生將獲邀請出席於2017年4月於香港摩天輪舉行的頒獎典禮。

The students will be invited to attend the prize presentation ceremony held at the Hong Kong Observation Wheel in April, 2017.

提交作品 Submission

參賽隊伍必須於2017年2月24日23時59分前，將填妥之報名表格及其作品之電腦檔案（掃瞄版本或照片均可，惟每個電郵必須小於5MB）發送至competition@hkow.hk。逾期、重覆發送或過大的電郵將不獲接納。

Participating team must submit the completed submission form and the designs (either a scanned version or photo format, each email should NOT exceed 5MB) by email to competition@hkow.hk before 23:59, February 24, 2017. Late submissions, re-submissions or file size exceeding the limit shall not be considered.



PRIMARY SCHOOL OBSERVATION WHEEL CABIN DESIGN COMPETITION

參加表格

Submission Form

組名 Group Name _____	學校 School: _____
組員(1至4位) Group Members: (min:1, max:4)	年齡 Age: _____
1 _____	年齡 Age: _____
2 _____	年齡 Age: _____
3 _____	年齡 Age: _____
4 _____	年齡 Age: _____
負責老師姓名 Teacher-in-charge's Name _____	聯絡電話 Contact Number: _____
創作意念(不多於50字) Design Concept (max: 50 words)	

*請簽妥文件最後一頁之比賽條款及細則以示同意
*Please sign to agree with the Competition Terms and Conditions on the last page of this document



PRIMARY SCHOOL OBSERVATION WHEEL CABIN DESIGN COMPETITION

比賽須知

Notes to applicants

本比賽由香港海洋公園保育基金及香港摩天輪聯合主辦（“主辦單位”）。

This Competition is co-organised by Ocean Park Conservation Foundation, Hong Kong and The Hong Kong Observation Wheel (“the Organisers”).

參賽隊伍必須由一至四位就讀同一所小學的學生組成，並由一位老師代表帶領，以便統籌及聯絡。

Participating team should be formed by one to four students studying in the same primary school, and led by one teacher who is responsible for communications.

每支參賽隊伍只可提交一份作品，主辦單位將以每個參賽隊伍首次成功提交的作品為該參賽隊伍的作品，任何其後修改或其他版本將不予受理。

Each participating team can only submit one entry, and the first successfully submitted entry by each school team will be taken as the official submission, any other subsequent modification or other versions will not be accepted.

比賽參加者必須為香港註冊小學的在學學生，每所小學之參賽隊伍數量不限。

This competition is open to students from primary schools registered in Hong Kong. There is no limit on the number of participating teams from each school.

提交日期及時間以主辦單位的伺服器接收記錄為準。主辦單位會發出確認電郵至參賽隊伍的電郵信箱，作為參賽隊伍已成功提交作品的正式證明。

The submission date and time are determined by the Organisers' server system. The organisers will issue a confirmation email to the school team's email account to confirm the entry is successfully accepted.

主辦單位將於2017年3月2日(星期四)在香港海洋公園保育基金的Facebook官方專頁<http://www.facebook.com/OPCFHK>上作公佈賽果。作品正本必須保持完整，以供賽後裱印之用。

The Organisers will publish the result on OPCFHK's Facebook page <http://www.facebook.com/OPCFHK> on March 2, 2017 (Thursday). To facilitate actual printing, please keep the original copy well.

車廂
Cabin Dimensions



2 - 200cm (w) x 58cm (h)



1 - 163cm (w) x 58cm (h)



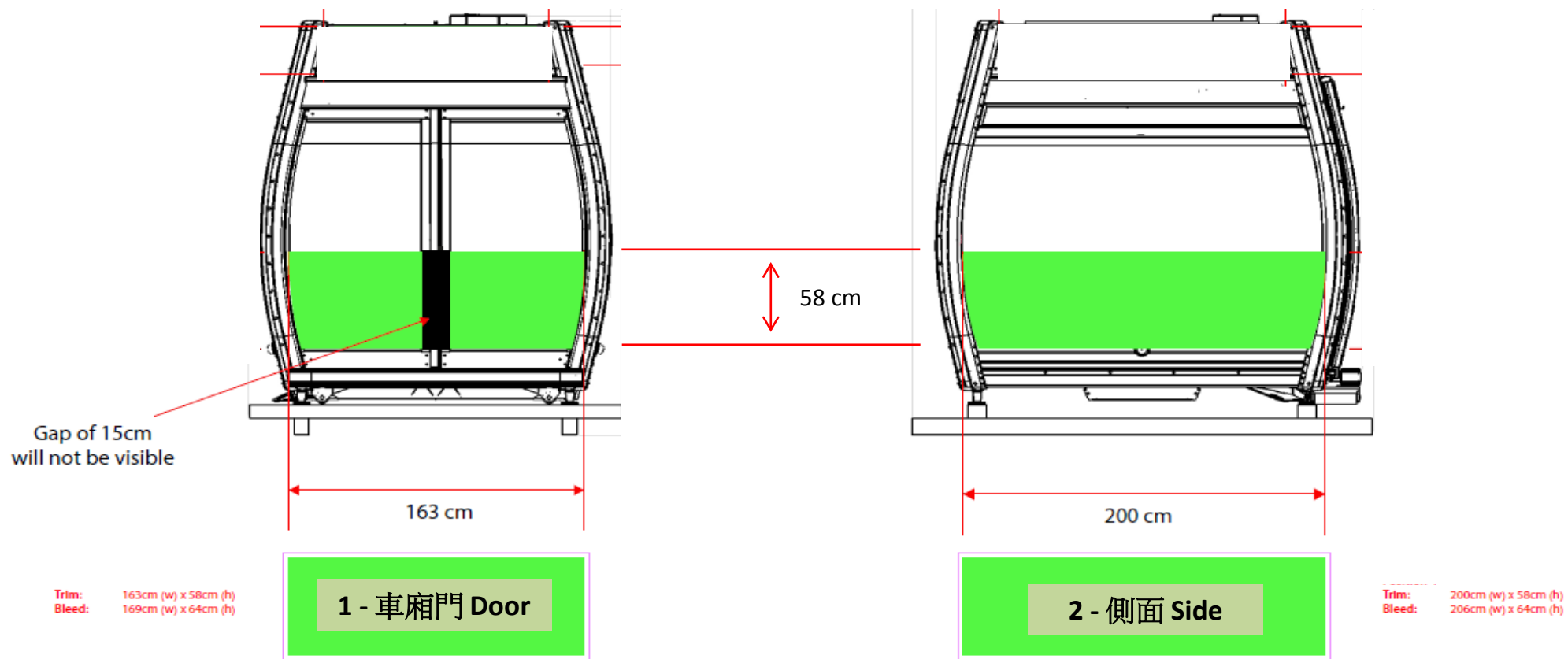

設計圖：請打印在A3紙張上，並繪畫於下圖方格內

Drawing diagram: please print on A3 paper and draw within the solid line

1A

位置一：車廂門(入口)
Position 1 – Door (Entrance)
163cm (w) x 58cm (h)

紫色位置為「出血位」，印刷時將有機會被裁剪，請確保該處並無重要資訊。
Purple zone is 'bleed zone'. These zones should contain content / artwork but will be partially cropped (cut-off). Do NOT leave important messages there.

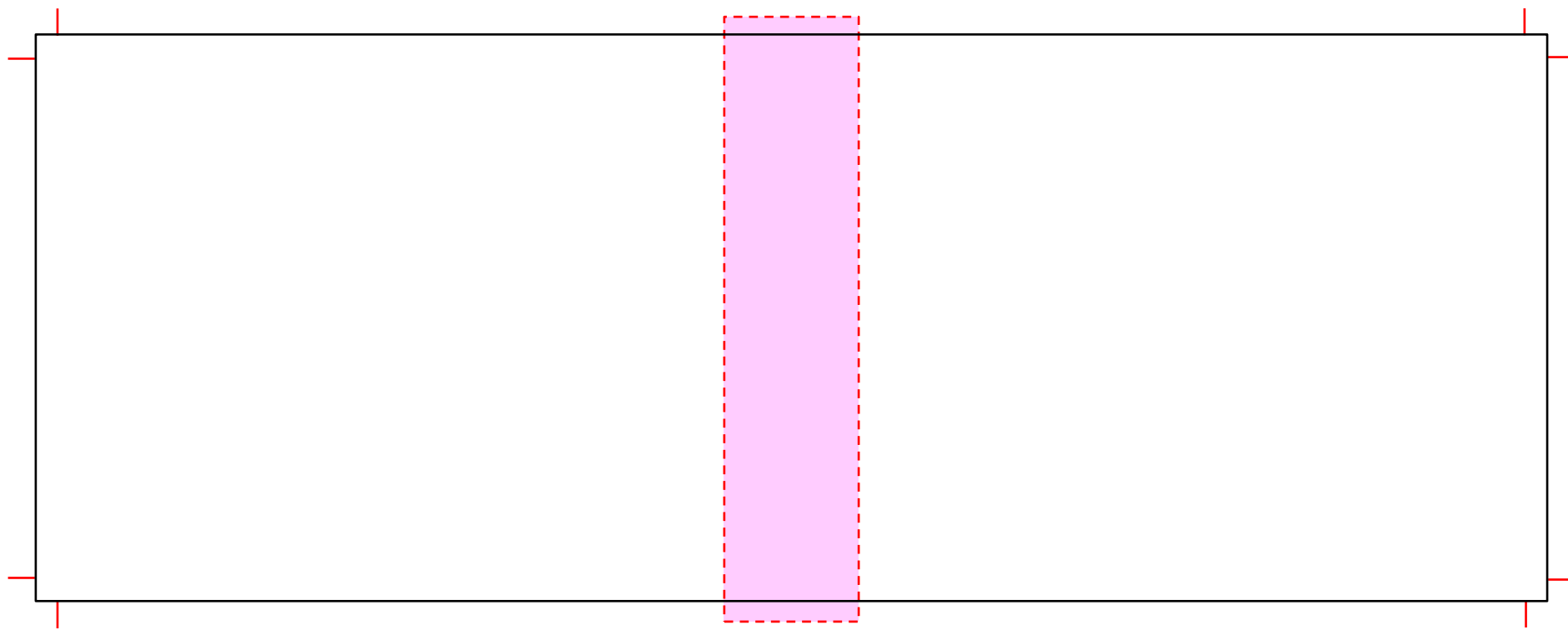
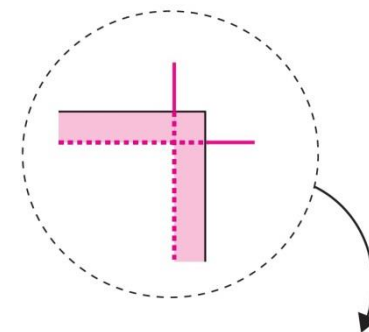

設計圖：請打印在A3紙張上，並繪畫於下圖方格內

Drawing diagram: please print on A3 paper and draw within the solid line

1B

位置一：車廂門(出口)

Position 1 – Door (Exit)

163cm (w) x 58cm (h)

紫色位置為「出血位」，印刷時將有機會被裁剪，請確保該處並無重要資訊。

Purple zone is 'bleed zone'. These zones should contain content / artwork but will be partially cropped (cut-off). Do NOT leave important messages there.

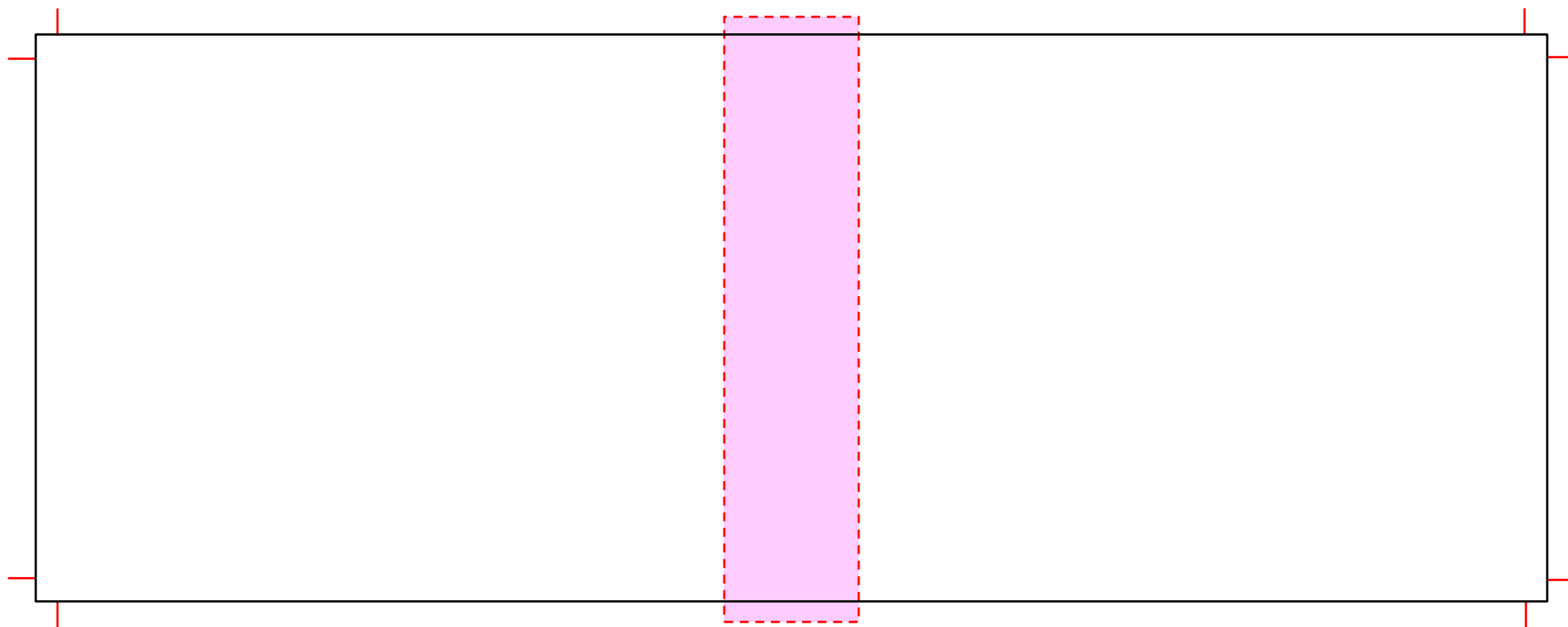
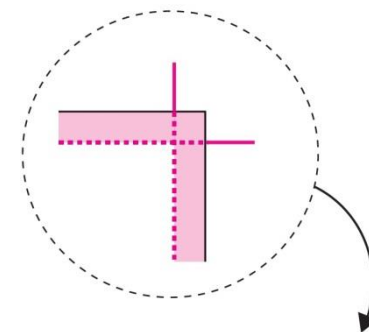

設計圖：請打印在A3紙張上，並繪畫於下圖方格內

Drawing diagram: please print on A3 paper and draw within the solid line

2A

位置二：側面(右)
Position 2 – side (right)
200cm (w) x 58cm (h)

紫色位置為「出血位」，印刷時將有機會被裁剪，請確保該處並無重要資訊。
Purple zone is 'bleed zone'. These zones should contain content / artwork but will be partially cropped (cut-off). Do NOT leave important messages there.

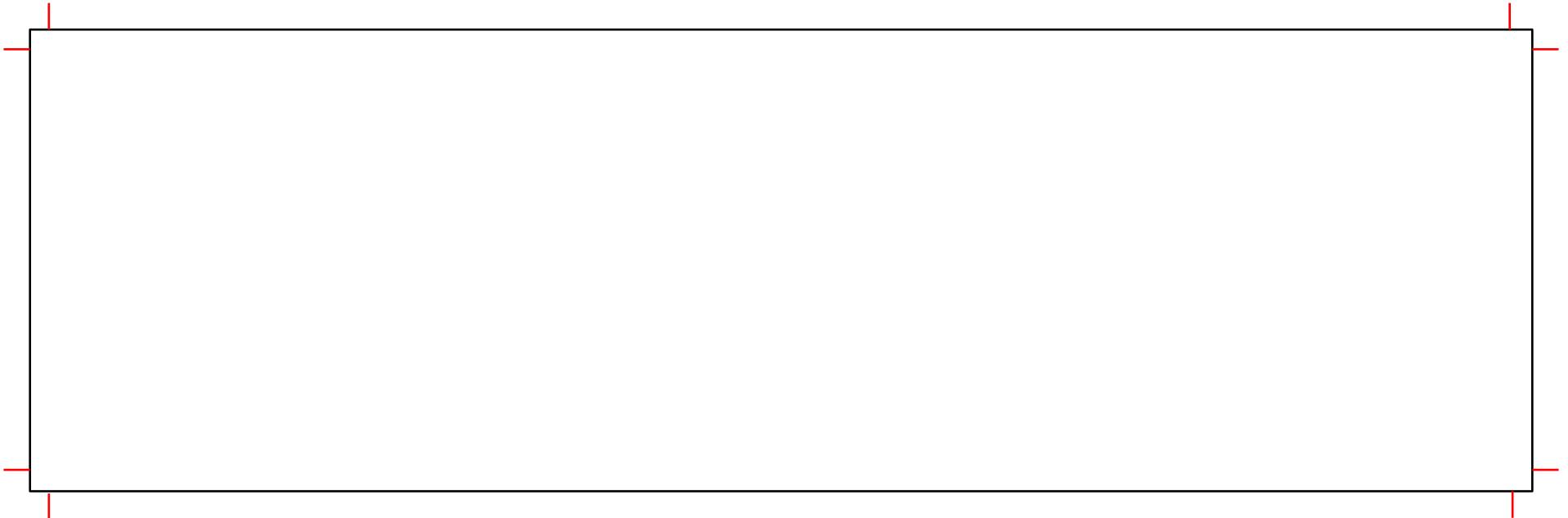
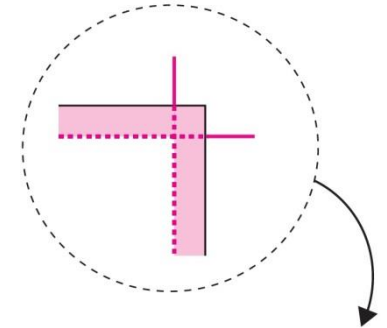

設計圖：請打印在A3紙張上，並繪畫於下圖方格內
Drawing diagram: please print on A3 paper and draw within the solid line

2B

位置二：側面(左)
Position 2 – side (left)
200cm (w) x 58cm (h)

紫色位置為「出血位」，印刷時將有機會被裁剪，請確保該處並無重要資訊。
Purple zone is 'bleed zone'. These zones should contain content / artwork but will be partially cropped (cut-off). Do NOT leave important messages there.

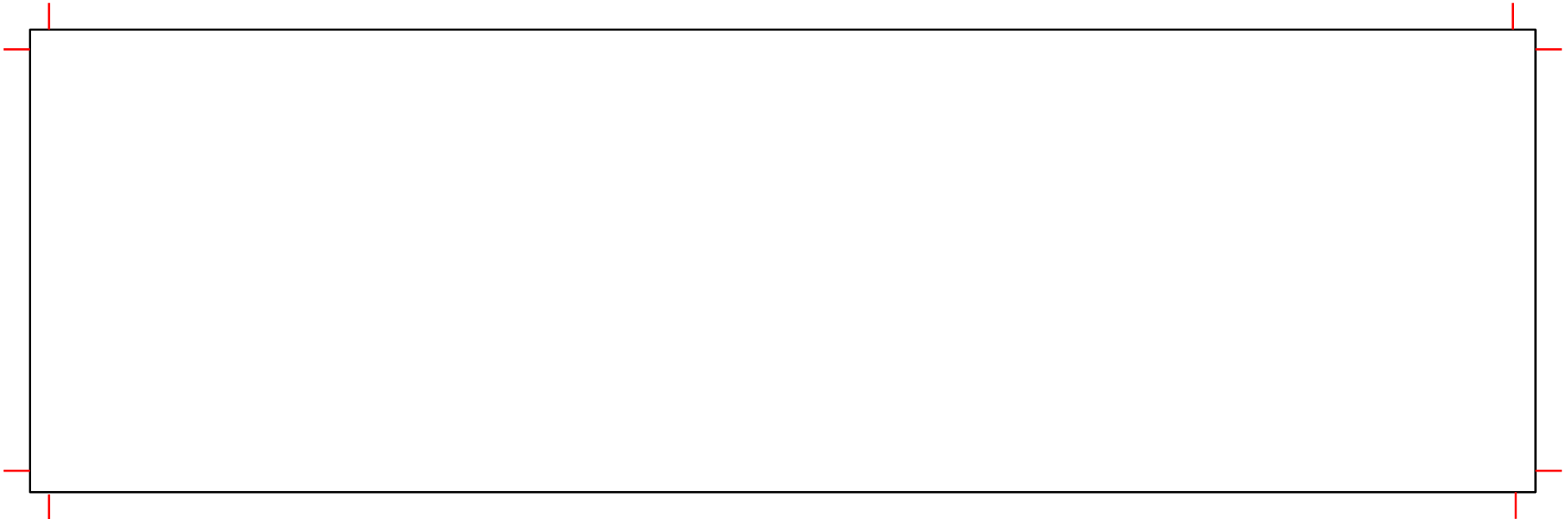
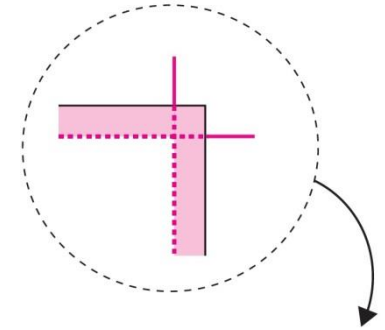

1

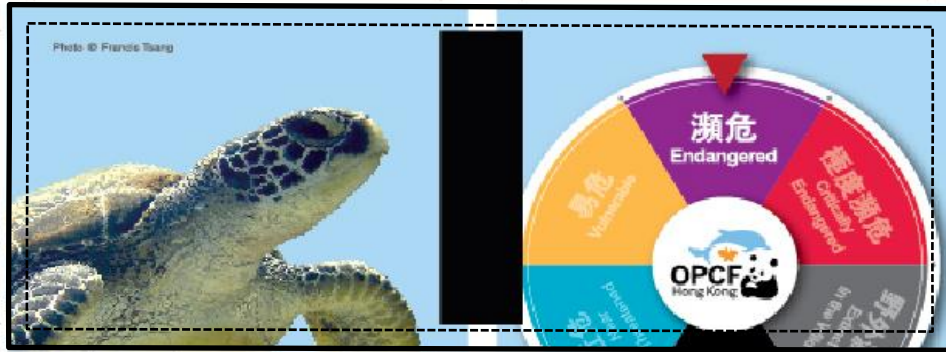

2



設計圖兩側將因應車廂弧度修剪，請確保該處並無重要資訊
Both sides of the drawing diagrams will be trimmed accordingly, do NOT leave important messages there.

提示 Notes to note:

請於實線方格內設計，虛線以外為「出血位」，印刷時將有機會被裁剪。
Please draw within the solid grid, dotted line area is the 'bleed zone'. These zones should contain content / artwork but will be partially cropped (cut-off).



設計時請運用較大圖案，讓車廂運行時仍能讓市民清楚看到，以達到推廣保護海洋的目的。

Please use larger graphics so the marine conservation messages could be clearly seen when the cabin is in operation.



比賽條款及細則 [學校隊伍]

Competition Terms and Conditions (for school teams)

1. 本比賽由香港摩天輪及香港海洋公園保育基金聯合主辦（“主辦單位”）。
This Competition is co-organised by Ocean Park Conservation Foundation, Hong Kong and The Hong Kong Observation Wheel (“the Organisers”).
2. 比賽參加者必須為香港註冊小學的在學學生，每所小學之參賽隊伍數量不限。
This competition is open to students from primary schools registered in Hong Kong. There is no limit on the number of participating teams from each school.
3. 參賽隊伍必須於 2017 年 2 月 24 日 23 時 59 分前，將填妥之報名表格及其作品之電腦檔案（掃描版本或照片均可，惟每個電郵必須小於 5MB）發送至 competition@hkow.hk。逾期、重覆發送或過大的電郵將不獲接納。
Participating team must submit the completed submission form and the designs (either a scanned version or photo format, each email should NOT exceed 5MB) by email to competition@hkow.hk before 23:59, February 24, 2017. Late submissions, re-submissions or file size exceeding the limit shall not be considered.
4. 提交日期及時間以主辦單位的伺服器接收記錄為準。主辦單位會發出確認電郵至參賽隊伍的電郵信箱，作為參賽隊伍已成功提交作品的正式證明。
The submission date and time are determined by the Organisers' server system. The organisers will issue a confirmation email to the school team's email account to confirm the entry is successfully accepted.
5. 參賽隊伍必須由 1 至 4 位學生組成，每個參賽隊伍最多只可提交一份作品，主辦單位將以每個參賽隊伍首次成功提交的作品為該參賽隊伍的作品，任何其後修改或其他版本將不予受理。
A school team should consist of 1-4 students. Each school team can only submit one entry, and the first successfully submitted entry will be taken as the official submission. Any other subsequent modification or other versions will not be accepted.
6. 主辦單位所委任的評審團（“評審團”）會根據大會評審標準對所有成功提交的作品作出評分，選出 40 個可獲裱印在摩天輪車廂上作展覽的得獎作品。
Judging panel appointed by the Organisers will score each entry according to the official judging criteria and select 40 winning designs which will be printed on the cabin for exhibition.

7. 主辦單位將根據參賽隊伍提交作品時所提供的聯絡方法，與參賽隊伍作任何有關是次比賽的聯絡。

The Organisers will contact school teams according to the contact information provided at the time of submission for any matters related to the Competition.

8. 若發生下列情況，主辦單位保留取消參賽隊伍資格的決定權：發現 (i) 有不正確或不完整的個人資料或連結、(ii) 參賽作品不符合參賽要求、(iii) 參賽作品被任何人士舉報涉及第 9 條所述情況。

The Organisers reserve the right to disqualify any school team if any of the following conditions occurs: (i) incomplete or incorrect personal information or link is submitted, (ii) entry does not comply with the requirement, (iii) entry is reported to violate clause 9 hereof.

9. 參賽隊伍須聲明及保證提交的作品均為原創以及由參賽隊伍自行創作，並未曾用作參加任何比賽或作公開發表。參賽隊伍亦須保證作品內所包括的任何元素和任何部份並無侵犯他人的權益 (包括但不限於肖像權、使用權、版權或其他專有或知識產權)。如任何作品涉及或被舉報侵犯此等第三者權益，主辦單位將保留取消參賽隊伍資格及 / 或得獎資格的最終決定權。

School teams must declare and guarantee the entries submitted are original works created by them, which have not been used to enter into any competition or published. School teams must also ensure all elements of the entries do not infringe any rights of the others (including but not limited to right of publicity, right of use, copyright and other proprietary or intellectual property rights). If any entry infringes or is reported to have infringed any of these rights, the Organisers reserve the final right to disqualify the school team and / or withdraw the award.

10. 作品不可含有暴力、淫穢、不雅或誹謗他人成份。若含有任何前述成份或內容引起任何人士作出投訴，主辦單位將保留取消參賽隊伍資格及 / 或得獎資格的最終決定權。

The entries must not contain any violence, obscene, indecent or slander content. If there is any such content or is complained by any party, the Organisers reserve the final right to disqualify the school team and / or withdraw the award.

11. 主辦單位有權以任何主辦單位認為合適的方式使用參賽隊伍的名稱、作品、拍攝照片及錄影片段的權利，包括但不限於在任何媒體或媒介複製、出版、刊登，或製作有關物品作非商業宣傳推廣用途，而毋須另行徵得參賽隊伍及 / 或任何第三方的同意或支付任何費用。參賽隊伍同意主辦單位有權利對作品作出修改。

The Organisers reserve the right to use the school teams' names and entries, take photos and videos in any way deemed appropriate by the Organisers, including but not limited to copy, publish, print or use in any media or production for non-commercial promotion, without prior consent of the school teams and / or any third party, or pay any fee. School teams agree that the Organisers have the right to make changes to the entries.

12. 評審團擁有對比賽結果的最終決定權，任何人不得異議。

The decision of the judging panel on the Competition results will be final and binding.

13. 主辦單位將於 2017 年 3 月 2 日(星期四) 在香港海洋公園保育基金的 Facebook 官方專頁 <http://www.facebook.com/OPCFHK> 上公佈賽果。

The Organisers will publish the result on OPCFHK's Facebook page <http://www.facebook.com/OPCFHK> on March 2, 2017 (Thursday).

14. 獎品不得轉讓、轉售、退換及兌換現金，並受有關條款及細則約束。獲獎參賽隊伍須自行負責就與獎品有關的稅項向有關當局作出申報和繳付，主辦單位對此不承擔任何相應責任。

All prizes are not transferable and not for sale, return or exchange for cash, and are subject to the related terms and conditions. Winning school teams should be solely responsible for reporting to relevant authorities and paying relevant taxes if necessary, and the Organisers will not be held responsible.

15. 主辦單位對獎品的性質、外觀、價值等不作任何承諾，獲獎參賽隊伍不得提出異議。

The Organisers do not make any guarantee as to the nature, appearance and value of the prizes, winning school teams shall not raise any objection.

16. 主辦單位就此比賽收集個人資料，用於進行比賽和確認參賽隊伍資格。已收集的個人資料僅用於此比賽中，包括比賽結果通知及領獎用途。完成相關用途後兩個月內相關個人資料將會被銷毀。

所有參賽隊伍有權向主辦單位查閱及改正其個人資料。參賽隊伍如欲行使這項權利，或對主辦單位的私隱政策有任何疑問，可參考官方網頁：

<http://www.opcf.org.hk/tc/footer/personal-Information-collection>

The Organisers collect personal data for the purpose of carrying out the Competition and for confirming the qualification of school teams. The collected personal data will only be used for this Competition only, including notification of result, prize arrangement and redemption. Data will be deleted within two months after such use.

School teams have the right of access to personal data held by the Organiser and to request correction of such personal data. If school teams wish to exercise these rights or have any questions on the Organiser's privacy policy, please refer to the official website: <http://www.opcf.org.hk/en/footer/personal-Information-collection>

17. 主辦單位保留修改所有條款及細則的權利並可隨時取消或中止比賽而毋須另行通知。

The Organisers reserve the right to adjust the Terms and Conditions, and cancel or terminate the Competition without notice.

18. 是次比賽及相關條款及細則於任何情況下均受到香港特別行政區法例的監管。所有參賽隊伍均有責任確保其參與是次比賽的行為及/或作品符合香港特別行政區的法律。若參賽隊伍就參與是次比賽而違反任何法律，主辦單位毋須負上任何責任，因此造成的任何損失，須由參賽隊伍承擔。

The Competition and the Terms and Conditions shall be governed in all respects by the laws of the Hong Kong SAR. All school teams are fully responsible for ensuring that their participation and / or the entries are lawful in accordance with the laws of the Hong Kong SAR. The Organisers shall not be taken to make any representations, express or implied, as to the lawlessness of any school team's participation. School teams shall be liable to any loss incurred.

19. 如有任何對是次比賽的條款及細則、處理、結果及其他有關事項的爭議，主辦單位保留最終決定權，任何人不得異議。

In case of any dispute regarding the Competition Terms and Conditions, arrangement, result and other related matters, the Organisers reserve the right to make the final decision.

參賽隊伍代表學校：

Representing school:

負責老師簽署及校方蓋章：

Teacher-in-charge's
signature and school chop:

日期：

Date: